

## Bracket R

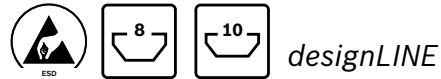

- ▶ For connecting profiles at any angle
- ▶ No protruding edges due to rounding of bracket
- ▶ Brackets with centering lugs for rapid, precise assembly with protection against turning
- ▶ Centering lugs can be easily broken off for assembly on plates or at right angles to the slot
- ▶ *designLINE* version with special silver paint (RAL 9006) for an attractive, high-quality design
- ▶ Profile finishing: not required

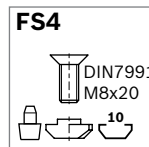
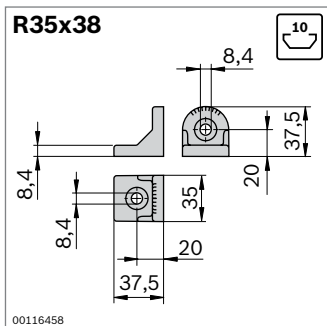
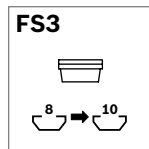
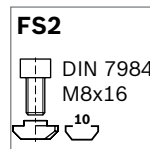
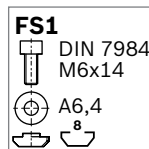
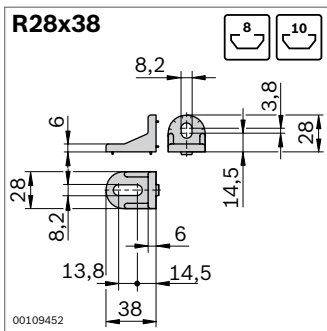

R28x38	Slot	ESD	No.	FS
Set (standard)	8 / 10	▲	1	<b>3 842 515 547</b> FS1, FS2, 2xFS3
	10 / 10	▲	1	<b>3 842 521 580</b> 2xFS2, 4xFS3
<i>designLINE</i> set	8 / 10	▲	1	<b>3 842 538 703</b> FS1, FS2, 2xFS3
	10 / 10	▲	1	<b>3 842 538 704</b> 2xFS2, 4xFS3
Bracket (standard)	8, 10	▲	100	<b>3 842 515 473</b>

Material: Bracket: diecast zinc  
*designLINE*bracket: painted (RAL 9006)  
Adapter: PA; black  
Fastening material: steel; galvanized  
Scope of delivery: set incl. fastening material (FS)

R35x38	Slot	ESD	No.	FS
Set (standard)	10 / 10	▲	1	<b>3 842 532 274</b> 2xFS4
<i>designLINE</i> set	10 / 10	▲	1	<b>3 842 538 705</b> 2xFS4
Bracket (standard)	10	▲	100	<b>3 842 529 020</b>

Material: Bracket: Die-cast aluminum  
*designLINE*bracket: painted (RAL 9006)  
Centering bolts: PA6, black  
Fastening material: steel; galvanized  
Scope of delivery: set incl. fastening material (FS)

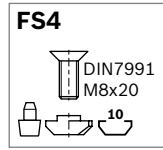
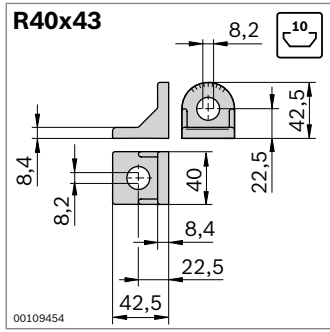

R40x43	Slot	ESD		No.	FS
Set (standard)	10 / 10		1	<b>3 842 518 424</b>	2xFS4
<i>designLINE</i> set	10 / 10		1	<b>3 842 538 706</b>	2xFS4
Bracket (standard)	10		100	<b>3 842 504 760</b>	

Material: Bracket: diecast zinc  
*designLINE* bracket: painted (RAL 9006)  
 Centering bolts: PA6, black  
 Fastening material: steel; galvanized

Scope of delivery: set incl. fastening material (FS)